

Digital Microscope

HRX-01

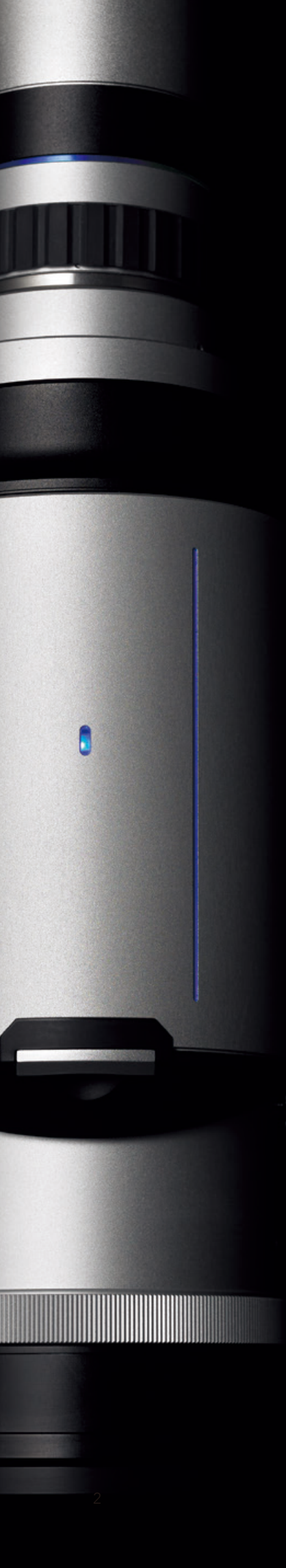



Absolute high resolution image

HR-1020E

Telecentric Ultra High Resolution Motorized Zoom Lens (10-200x)

Astounding resolution, Accuracy, Usability. Aggregating the potential of telecentric lenses to the maximum

Introducing the new Hirox masterpiece: the new motorized telecentric zoom lens HR-1020E is the result of over 40 years of optical manufacturing and engineering excellence. Combined with the HRX-01, intelligent sensors compute in real time the lens zoom information, detect illumination adapters, register XY and Z position and record those conditions to redefine completely the user experience.

- Large aperture lens provides super high resolution and crystal clear image
- Fully motorized zoom lens for easy operation and improved accuracy
- Telecentric lens without distortion for precise measurement
- Wide angle high resolution one-shot observation with magnification starting from 10x

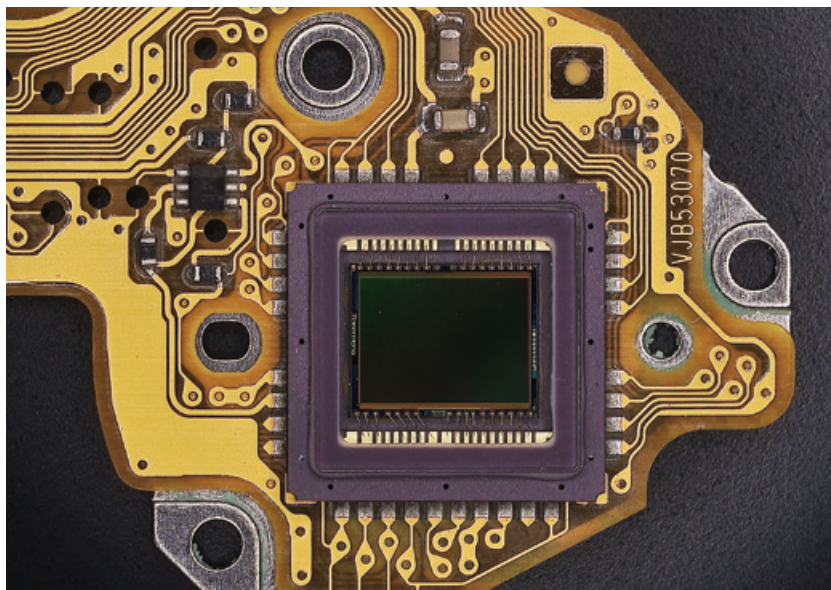

Mounted board(10x)

New Digital Microscope Control Unit

HRX-01 System

Ultra High Resolution Camera Unit

The HRX-01 features a brand new high resolution camera, a newly developed intelligent stand combined with high end motorized lenses, bringing digital microscopy to a completely new level.

Because we know that each customers needs is unique, it's easy to customize your system using the most advanced lens, stand, software and PC for YOUR specific observation applications.



Ultra High Resolution 5.0 Mega Pixel Camera

Newly developed 5.0 Mega pixel CMOS chip supporting ultra high resolution with 50 frames per second providing crystal clear images.

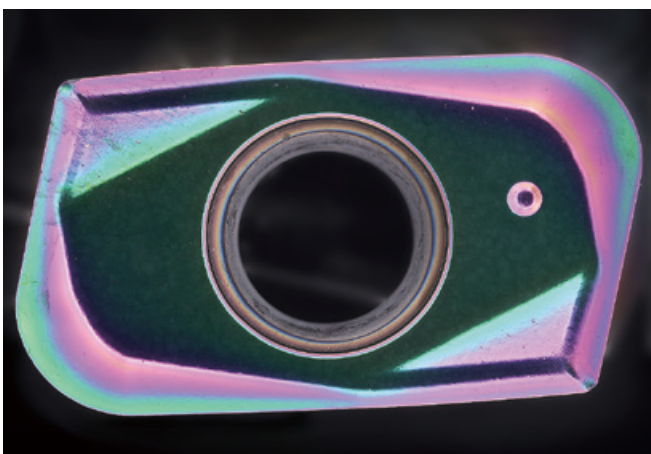

Live HDR - Automatic Optimization of Live Images

The HRX-01 artificial intelligence automatically select the optimal observation settings according to the observation scene and object.

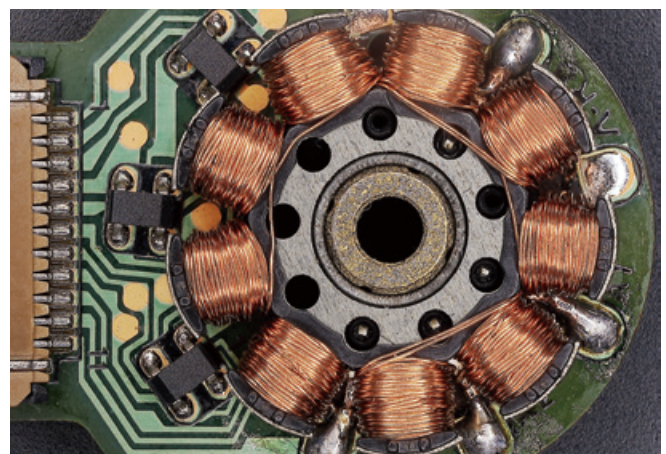

Easy High Speed Interface

The choice to use a separate workstation PC allows end-users to meet the diversified needs of many types of working environments and ability to upgrade the PC. IT professionals have the ability to access, maintain and secure PCs for network use.



Platform Compatible with Surface Studio and 4K PCs

Select necessary application software and features for personal preferences and samples. Capability to create and save individual operators' customized setting for daily use.

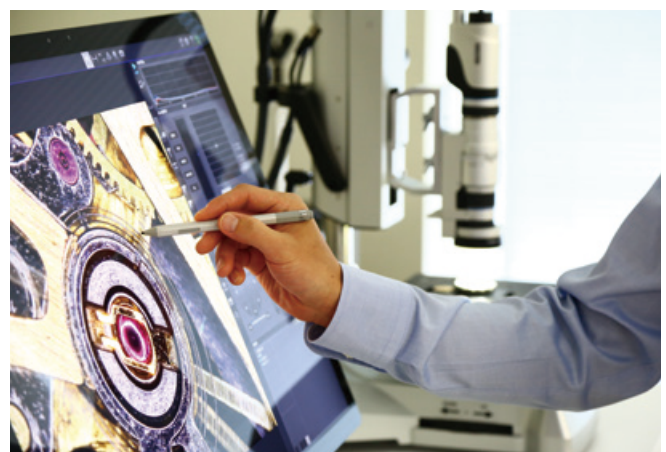

Hirox Lens Series

Motorsized zoom, fast magnetic snap-on adapters with software recognition makes the operation easy, even for users who never used a digital microscope before.

Telecentric Ultra High Resolution Motorized Zoom Lens 10-200x

HR-1020E

Hirox developed a new and unique telecentric zoom lens covering a wide zoom range from 10x to 200x with guaranteed measurement results. This high resolution motorized lens captures images with NO distortion and a wide field of view.



Item Number	HR-1020E								
Magnification	10x	20x	30x	50x	90x	100x	120x	150x	200x
Working Distance (mm/inch)	54(2.13)								
Horizontal View (mm/inch)	30.5(1.2)~1.52(0.06)								
Motorized Control	Zoom								

High Range Turret Motorized Zoom Lens 20-2500x

HR-2500E

The very popular Hirox revolver zoom lens has been updated, covering now a wider magnification zoom, from 20 up to 2500 times, for seamless observation from low to high magnification. The motorized zoom, objective change and illumination selection (bright field, dark field or mixed) offer unprecedented ease of use and performance.



Item Number	HR-2500E						
Magnification	Low-Range	20x	30x	50x	80x	120x	140x
	Mid-Range	140x	200x	400x	600x	800x	1000x
	High-Range	350x	500x	1000x	1500x	2000x	2500x
Working Distance (mm/inch)	Low-Range: 18(0.71) / Mid-Range & High-Range: 10(0.39)						
Horizontal View (mm/inch)	15.4(0.61)~0.12(4.72mil)						
Motorized Control	Zoom / Turret / Light Select (Bright Field, Dark Field or Mixed)						

Super High Range Turret Motorized Zoom Lens 20-5000x

HR-5000E

For high demanding customers in need of very fine details, the super high range motorized revolver zoom lens can zoom up to 5000x, with an optical magnification ratio of 250 times without need for dismantling the lens. A universal lens that supports various objects and observation scenes. And just like the HR-2500E, zoom, objective change and illumination selection (bright field, dark field or mixed) are motorized.



Item Number	HR-5000E						
Magnification	Low-Range	20x	30x	50x	80x	120x	140x
	Mid-Range	140x	200x	400x	600x	800x	1000x
	High-Range	700x	1000x	1750x	3500x	4000x	5000x
Working Distance (mm/inch)	Low-Range: 18(0.71) / Mid-Range: 10(0.39) / High-Range: 3.4(0.13)						
Horizontal View (mm/inch)	15.4(0.61)~0.06(2.36mil)						
Motorized Control	Zoom / Turret / Light Select (Bright Field, Dark Field or Mixed)						

Low Range Motorized Zoom Lens 20-160x

HR-2016E

This high-performance zoom lens features compact body and high resolution image covers a total magnification range from 6-320x, while offering a large optical depth of field. This lens can be used as handheld in contact or have a working distance over 130 mm depending on the adapter. The new magnetic mounting system allow quick change of adapters, including the world's famous Hirox Rotary Head, covering a very wide range of applications.



Item Number	HR-2016E							
Magnification	20x	30x	40x	50x	80x	100x	130x	160x
Working Distance (mm/inch)	44(1.73)							
Horizontal View (mm/inch)	15.4(0.61)~2.0(0.08)							
Adapter Recognition	Yes							
Motorized Control	Zoom / Rotary-Head							

Middle Range Motorized Zoom Lens 50-400x

HR-5040E

This mid range zoom lens offers a large depth of field, with a long working distance, good resolution and realistic observation unique to large aperture lenses. With a wide zoom range, this lens is for customer that needs fast and easy observation at mid zoom of objects with high altitude differences.



Item Number	HR-5040E							
Magnification	50x	100x	150x	200x	250x	300x	350x	400x
Working Distance (mm/inch)	54(2.13)							
Horizontal View (mm/inch)	6.1(0.24)~0.78(0.03)							
Adapter Recognition	Yes							
Motorized Control	Zoom / Rotary-Head							

High Resolution Motorized 10x Zoom Lens 35-10000x

HR-10CE

With seven interchangeable objective lenses, this optical zoom lens incorporates high expandability and the highest resolution in the series, covering a magnification range of 35-10000x. A directional lighting adapter is included for coaxial vertical lighting to achieve the finest optical observation at sub-micron level.

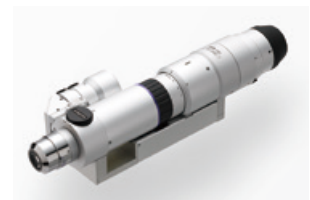

Item Number	HR-10CE					
Objective Lens / Magnification / Working Distance (mm/inch)	OL-35	35~350x	34(1.34)	OL-350II	350~3500x	10.6(0.42)
	OL-70II	70~700x	21(0.83)	OL-700II	700~7000x	3.4(0.13)
	OL-140	140~1400x	30.5(1.20)	OL-1000	1000~10000x	1.0(0.39)
	OL-140II	140~1400x	12(0.47)			
Horizontal View (mm/inch)	9.83(0.39)~0.03(1.18mil)					
Motorized Control	Zoom					

Macro Zoom Lens 0-50x / **Macro Lens** 0-20x

MXB-050Z / MXB-MACRO

Perfect for observation and documentation of large objects. The MXB-Macro is using available light with a zoom depending on the working distance, giving very good results at affordable price, while the MXB-050Z offers built in ring light and calibrated zoom for advanced macro observations up to 50x.



Item Number	MXB-050Z	MXB-MACRO
Magnification	0-50x	0-20x
Working Distance(mm/inch)	infinity ~ 90(3.54)	—
Horizontal View (mm/inch)	infinity ~ 61(2.40)	infinity ~ 15.4(0.61)

NEW High Precision Free Angle Stand

Precision control of 0.05um

Hirox created a completely new inclination stand featuring multiple integrated sensors and a high precision 80 mm motorized Z movement, providing the highest level of accuracy for various applications.

The XY stage can be motorized (50x50mm or 100x100mm) for automatic XYZ acquisition, or manual. The stand also integrates built-in transmitted illumination, controlled by the HRX-01 software, increasing the observations capabilities, as well as antivibration feet for improved stability. Thanks to various sensors - including height and angle - the ST-AS stand truly supports the users, offering intelligent & stress-free observation.

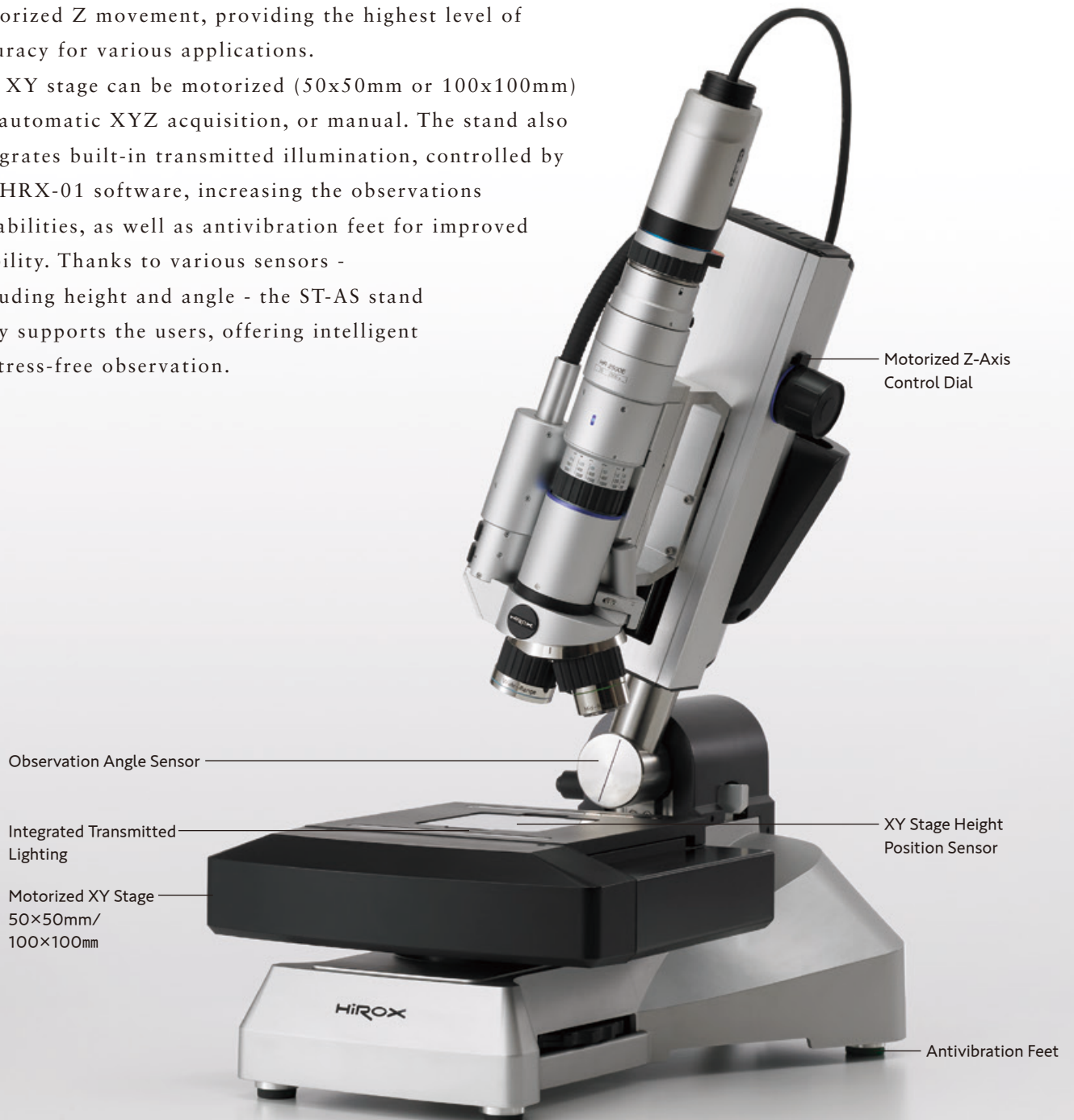

Multiple Lighting Capability

The ST-AS stand can expand lighting options, such as transmission illumination, but also it allows controllable additional external lighting such as the newly developed dual side lighting option, offering higher flexibility of observation.



Observation Angle Sensor

The new inclination detection sensor displays and records the angle information within the captured image (jpg metadata), enabling a higher level of reproducibility.



High Precision Manual Stand

For simple observation applications, the manual XYZ stand is also a very good and cost-effective option.



Large Stand

Large XY Stand is suitable for an observation of big and heavy sample. The arm's height can be adjusted in Z or in Y direction and a large XY stage can be added if needed.



New Design Application Platform

Live-Focus

This standard function instantaneously creates a fully focused image of the area even for objects with high differences in height. Anyone can easily perform this expanded observation without being limited by the depth of field.



2D & 3D Tiling

Just select the area of interest and the image will automatically begin stitching seamlessly in real-time with the motorized XYZ stage creating amazing high optical resolution images with a wide field of view simultaneously. And with the “map” function, the tiled image is displayed on the screen so you just need to click on the map to bring the stage to the clicked position.



2D Measurement

Accurate and calibrated measurements in real-time, including length, area, angle, diameter, and automatic surface area. The combination of encoded optics and powerful software eliminates any human errors by automatically selecting and displaying the correct lens, adapter, and scale on the screen at any time.

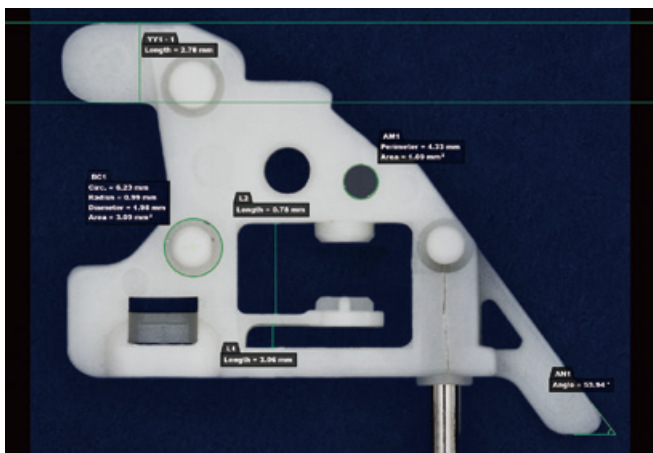

Excel Reports with One Click

This feature enables one-click export of images, measurement results, statistics & image information into an Excel sheet. The report format can be easily customized so that you can create your own report with company information. The integration between the HRX-01 and Windows is seamless and offers great flexibility.

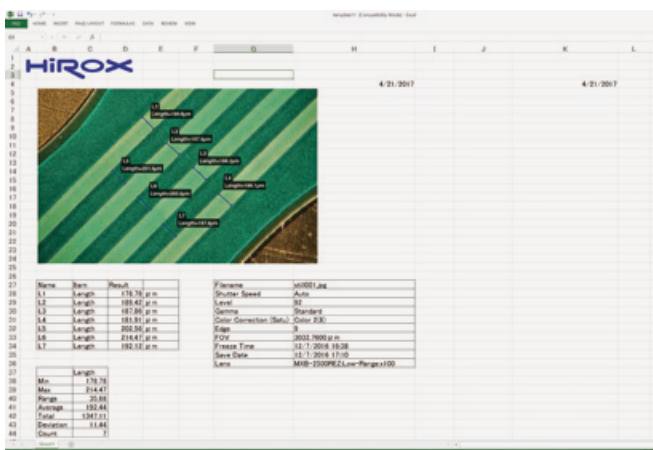

3D Measurement / Profiling

Simply adjust the profile slicer to visualize and measure any details on the 3D object: the profile created is like a virtual cross section allowing precise measurements. Using the profile measurement function, it's very simple to measure height, volume, roughness, angle or radius for example by simply "drawing" a circle with 3 points.

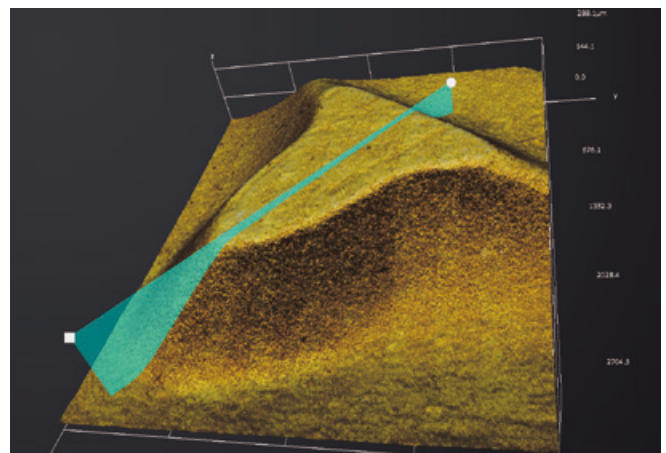

Contamination Analyzer (ISO16232 Compliant)

Particles are automatically detected with pass/fail judgment by settable threshold. Advanced statistical data with histogram and frequency distribution are automatically calculated and displayed in Excel. It's very easy to measure the shape of every particle or cells, from metal particles to animal cells.

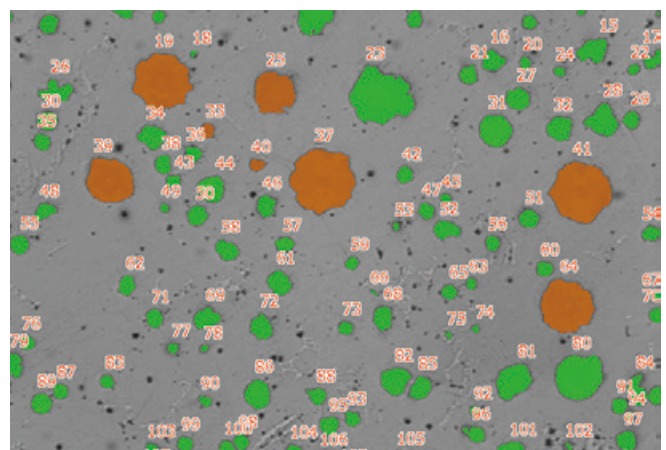

Hirox System Line Up

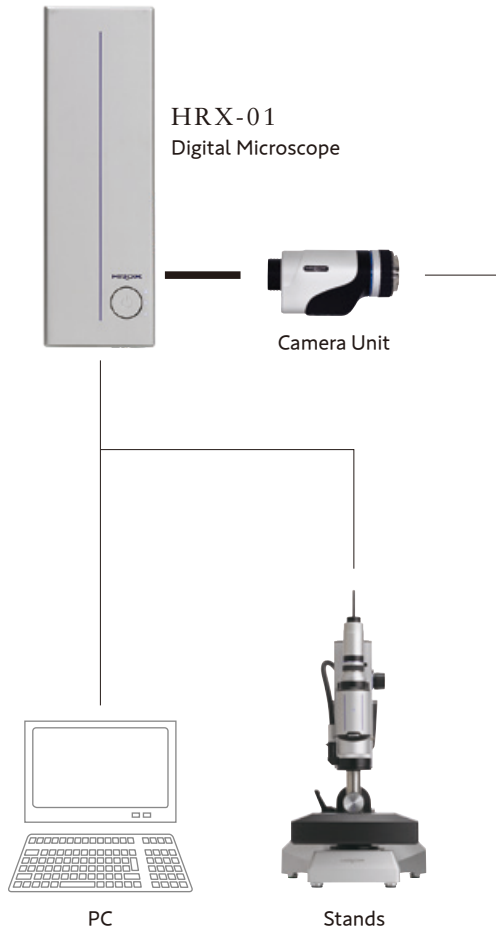

Lens

- 

HR-1020E
Telecentric Ultra High Resolution
Motorized Zoom Lens (10-200x)
- 

HR-2016E
Low Range Motorized Zoom Lens
(20-160x)
- 

HR-5040E
Middle Range Motorized Zoom Lens
(50-400x)
- 

HR-2500E
High Range Turret
Motorized Zoom Lens (20-2500x)
- 

HR-5000E
Super High Range Turret
Motorized Zoom Lens (20-5000x)
- 

HR-10CE
High Resolution
Motorized 10x Zoom Lens
- 

MXB-050Z
Macro Zoom Lens (0-50x)
- 

MXB-MACRO
Macro Lens (0-20x)

Advanced Software *option

- HRS-3D 3D Measurement Software
- HRS-TL Tiling Software
- SP-Software Contamination Analyzer

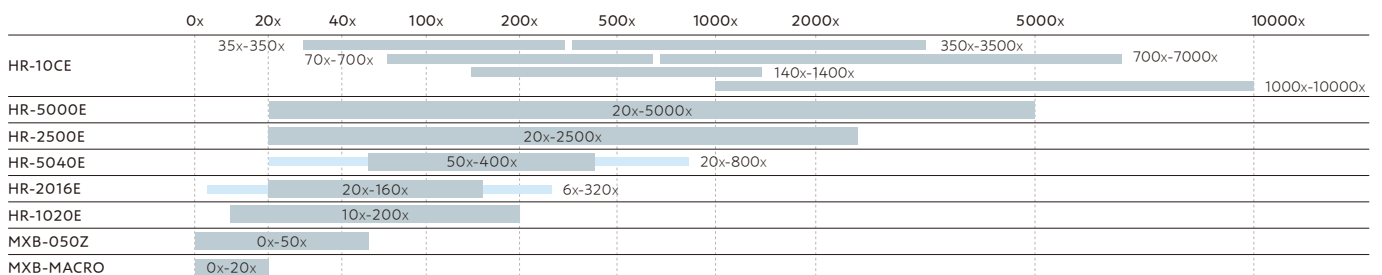

※ Magnification with adapter

Adapter

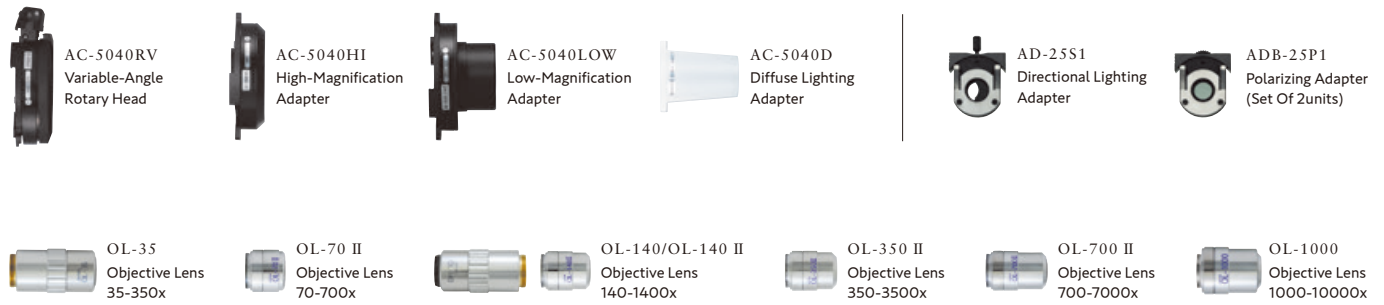

More various optional adapters for each lenses.

High Precision Stands



	HRX-01			
	Digital Microscope	All-In-One PC	Lens / Stands	
	Standard System			
	3D Measurement System			
	Tiling System			
	Full System			
Standard Functions*	●	●	●	●
3D Measurement	—	●	—	●
Tiling	—	—	●	●

* Observation, Capture, Multi-Focus, 2D Measurement, Create 3D data

Custom-made items from Hirox

As the company started from specialized lens manufacture, HIROX has a long experience in designing, engineering, producing and delivering various customized lenses, adapters and stands to meet special requirements of our customers - making our system the most universal and flexible system in the world. These are examples of HIROX custom made stands to provide the best observation ability. For more detailed information, please contact us!

Free angle stand with rotational mechanism sample holder

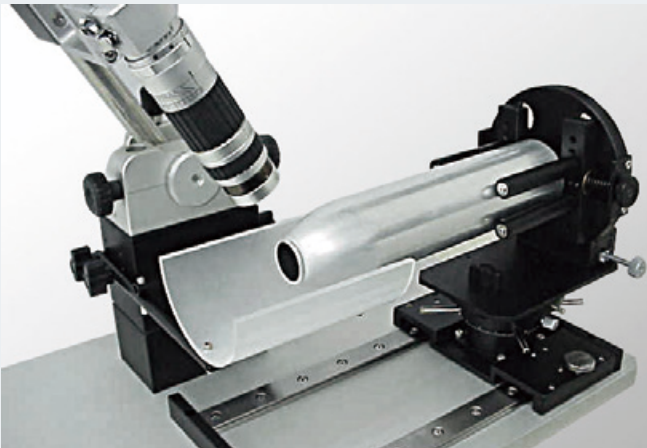

Inverted stand

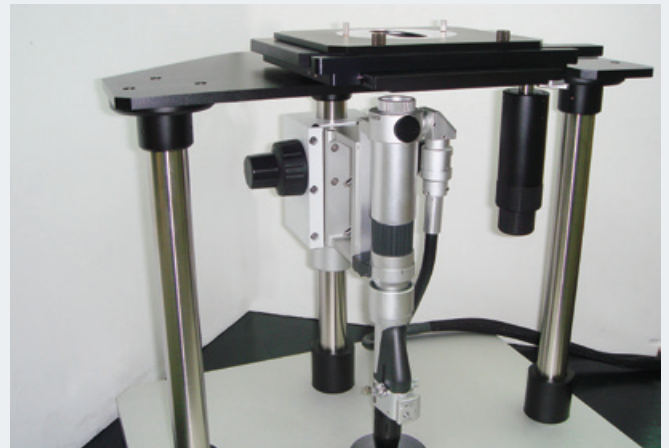

Flexible arm stand with motorized Z-axis



Super large stand system

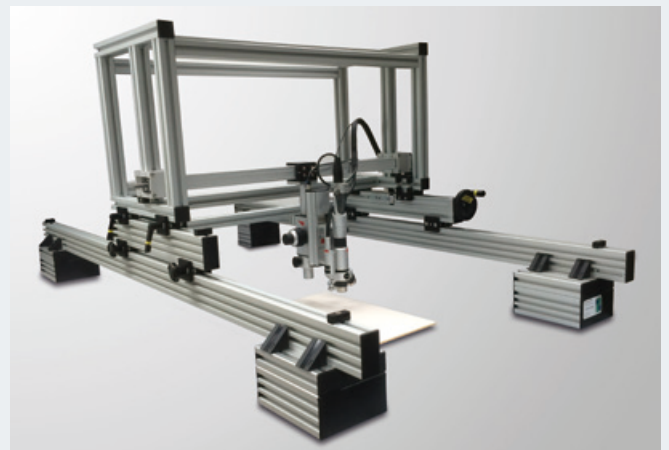

HRX-01

Basic Function: Main Unit

Camera	Imaging Device	2/3inch 5.07Mega-Pixel CMOS Image Sensor Global Shutter Type	
	Total Pixels	2464 (H) x 2066 (V)	
	Effective Pixels	2448 (H) x 2048 (V)	
	Scanning Method	Progressive Scan	
	Sensor Pixel Size	3.45 (H) x 3.45 um (V)	
	Frame Rate	50F/S (max)	
	Recording Image Size		2448 (H) x 2048 (V)
			2040 (H) x 1530 (V)
			1958 (H) x 1638 (V)
			1632 (H) x 1224 (V)
	Electronic Shutter	1~1/25000	
	Gain	0dB ~ 12dB	
White Balance	AUTO (One Push) / MANUAL		
Image Processing Engine	HDR Function	Real-Time Display	
Light Source	Lamp Type	High Intensity LED	
	Lamp Life	30,000 hours (Average)	
	Color Temperature	5700K (Typ)	
Interface	PC Out	USB3.0 (Type B)	
	Stand Out	Special ST-AS connection	
	Expansion Port	USB3.0 (Type A) rear panel x2	
Power	Supply Voltage	AC100V~240V 50/60Hz	
	Consumption	200W	
Environmental Resistance	Ambient Temperature	5~40°C (41 ~ 104F)	
	Relative Humidity	20~80% (No Condensation)	
	Storage Temperature	-15~50°C (5 ~ 122F, No Condensation)	
	Atmosphere	Corrosive Gas Prohibited	
Weight	Main Unit	2.5kg (7.9lb)	
	Camera Unit	1kg (2.2lb)	
Dimension [not include projection part]	Main Unit	130 (W) x 243.6 (V) x 275 (H) mm 51.2 (W) x 95.9 (V) x 108.3 (H) inch [including stand base part]	

Basic Function: STAND

Stand Base	Free Angle Type
	Tilt Angle Range: Right 90°, Left 60°
	Center angle position lock mechanism
	Tilt torsion spring mechanism
	Tilt angle sensor
	Stage vertical position movement mechanism
	Anti vibration mechanism
	Standardized transmitted lighting LED
	Optional expandable lighting capability (with power supply and software control)
	Motorized XY and Z axis driver mounted
Motorized Z axis	Motorized (dial control for manual like operation and software control)
	Motor: 5 phase stepping motor
	Resolution: 0.05um
	Effective Stroke: 80mm
Motorized XY Stage	Motor: 2 phase stepping motor
	Effective Stroke: 50 x 50mm type or 100 x 100mm type
	Transmitted light LED mounted (with black plate and clear plate)

PC Recommended Specification

OS	Windows10 64bit
CPU	intel Core i5 7th gen or better
Memory	16GB or better
Hard Drive	512GB or better (HDD/SSD)
Interface	USB3.0 Type A x 4

Monitor Recommended Specification

Resolution	4K (3840x2160)
------------	----------------

**Above specification of PC and monitor are not to guarantee the operation.



Hirox Co.,Ltd. <https://www.hirox.com>
2-15-17 Koenji Minami,Suginami-ku,Tokyo166-0003,Japan
Tel:(+81) 3-3311-9911 Fax:(+81) 3-3311-7722 E-mail:tokyo2@hirox.com

Hirox-USA Inc. <http://www.hirox-usa.com>
100 Commerce Way, Hackensack, NJ 07601
Tel:(201)342-2600 Fax:(201) 342-7322
Toll-Free:(866)HIROX-US E-mail:info@hirox-usa.com

Hirox China Co.,Ltd. <http://www.hirox.com.cn>
Room 809, 8th Floor, Fortune International Plaza,
No.43 Guo-Quan Road, Shanghai 200433, China.
Tel:+86-21-6564-7772 Fax:+86-21-3362-5017 Email:info@hirox.com.cn

Hirox Korea Co.,Ltd. <http://www.hiroxkorea.com>
B-501 Acrotower Bldg, 1591 Gwanyang-dong, Dongan-ku, Anyang-city,
Gyeonggi-do, 431-908, Korea
Tel:+82-31-385-1130 Fax:+82-31-385-9730 E-mail:yoon@hiroxkorea.com

Hirox Asia Ltd. <http://www.hirox-asia.com>
Unit 827, 8/F, Ocean Centre, Harbour City, 5 Canton Road,
Tsimshatsui Kowloon, Hong Kong
Tel:+852 8198-9679 Fax: +852 3015-7657 E-mail:info@hirox-asia.com

Hirox Europe Ltd. <http://www.hirox-europe.com>
Jyfel, 300 RN 6 Le Bois des Côtes, Bâtiment A F-69760 Limonest, France
Tel:+33 426 25 03 40 Fax:+33 426 23 68 13 E-mail:info@hirox-europe.com

Contact



AXT PTY LTD
Authorised Distributor
HIROX
Australia & New Zealand

1/3 Vuko Place
Warriewood
NSW 2102 Australia

+61 (0)2 9450 1359
axt.com.au
info@axt.com.au

The products in this catalog may be changed at any time, without notice.

PHP-1908-C055-A_
APP-P1908-0099